

KLS martin GROUP

Produktinformation

Wir beraten Sie gerne:

KS Medizintechnik Handels GmbH
Karthäuser Straße 21
34587 Felsberg

Tel. 0 56 62 - 40 111-0
Fax 0 56 62 - 40 111-9000
info@ksmedizintechnik.de

Kostenlose
Servicenummer:
0800 - 10 10 871

www.ksmedizintechnik.de

Headlights



MedLED Sapphire™
MedLED Onyx™

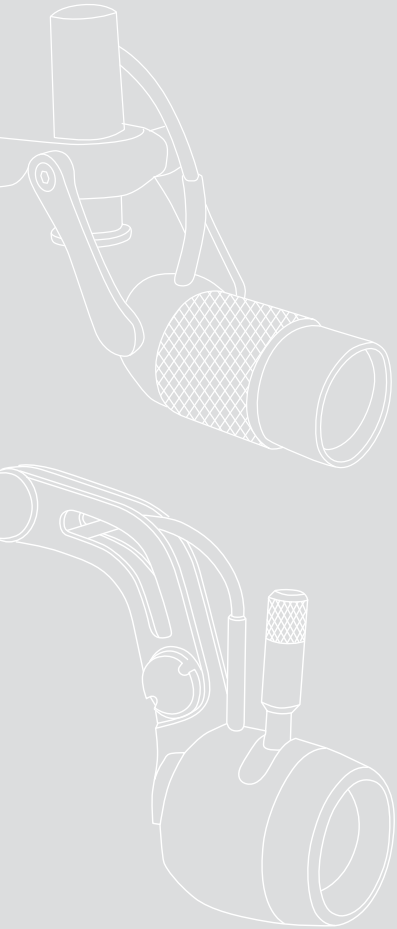



„Eine optimale Ausleuchtung des OP-Feldes ist für mich als MKG-Chirurg von größter Wichtigkeit. Das kräftige Licht der MedLED-Stirnleuchten bietet sowohl für intra- als auch extraorale Eingriffe die nötige Beleuchtungsstärke bei einer sehr langen Betriebsdauer von fast sieben Stunden.“

“For myself as an oral and maxillofacial surgeon, optimal illumination of the surgical field is extremely important. The powerful light of the MedLED headlights provides the required luminous intensity for intraoral and extraoral surgery and its operating time of nearly 7 hours is very long.”



Prof. Dr. Dr. Jürgen Hoffmann

Medical director of the clinic and outpatient clinic for oral and maxillofacial surgery, Heidelberg University Hospital

„Die MedLED Sapphire™ der KLS Martin Group ist die erste Stirnleuchte, die mich von Anfang an komplett überzeugt hat. Handhabung, Lichtstärke und Vergrößerungsmöglichkeit sind für Sprechstunde und OP optimal.“

“The MedLED Sapphire™ from KLS Martin is the first headlight that won me over completely right from the start. The handling, the light intensity and the zoom lenses make it simply ideal for patient consultation as well as surgery.”



Dr. med. Paul-Stefan Mauz

Senior Consultant Tübingen University Hospital
Department of Otorhinolaryngology

MedLED Sapphire™ MedLED Onyx™

Für klarste Sicht.

Die MedLED Sapphire™ und die MedLED Onyx™ von KLS Martin setzen neue Maßstäbe im Bereich der Premium-Stirnleuchten. Sie bieten höchsten Tragekomfort, liefern erstklassiges Licht und warten mit besonders leistungsstarken Batterien auf.

Die MedLED Sapphire™ ist mit ihrer unschlagbaren Lichtstärke bestens für Operationen geeignet, bei denen eine sehr gute Tiefenausleuchtung des Operationsfeldes verlangt wird.

Die MedLED Onyx™ bietet hingegen eine sehr gute Ausleuchtung bei Eingriffen, die eine homogene und große Ausleuchtung des Operationsfeldes verlangen.

Merkmale

- Stirnbanddesign für höchsten Tragekomfort
- Lichtstärke bis zu:
 - 200.000 Lux (MedLED Sapphire™)
 - 100.000 Lux (MedLED Onyx™)
- Farbtemperatur: 5.000 K
- Batteriebetriebsdauer mindestens 6,5 Stunden
- Batterieladezeit 6 Stunden
- Schneller und einfacher Batteriewechsel ohne Abschaltung
- Schnelles Laden mit USB-Kabel (via Wandadapter oder PC)
- Integrierte Batterieladezustandsanzeigen
- Stufenlose digitale Dimmung
- Gesamtgewicht:
 - 310 g (MedLED Sapphire™)
 - 375 g (MedLED Onyx™)

For extremely clear vision.

MedLED Sapphire™ and MedLED Onyx™ by KLS Martin set new standards in the field of premium-category headlights. They provide maximum wearing comfort, supply first-class light and feature outstandingly high-performance batteries.

With its unbeatable light intensity the MedLED Sapphire™ is ideally suited for operations where depth illumination of the surgical field has to be excellent.

The MedLED Onyx™, on the other hand, offers outstanding illumination in operations that call for homogeneous, wide illumination of the surgical field.

Features

- Comfort emphasized strap design
- Luminous intensity up to:
 - 200,000 Lux (MedLED Sapphire™)
 - 100,000 Lux (MedLED Onyx™)
- Color temperature: 5,000 K
- Battery service life: min. 6.5 hrs
- Charging time: 6 hrs
- Fast and easy battery change, without powering off
- Rapid USB charging from wall adapter or PC
- Integrated battery status indicators
- Continuous digital dimming
- Total weight:
 - 310 g (MedLED Sapphire™)
 - 375 g (MedLED Onyx™)



MedLED Sapphire™

Vorteile

- Optimale Tiefenausleuchtung
- Höchste Lichtstärke in ihrer Klasse

Advantages

- Optimal depth illumination
- Highest level of light intensity in its class

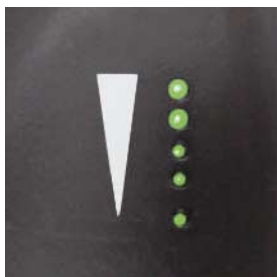
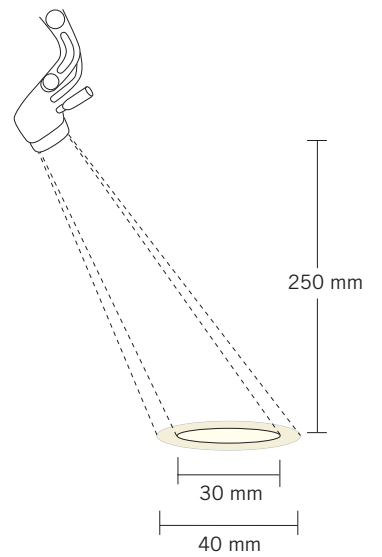
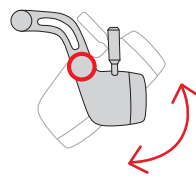
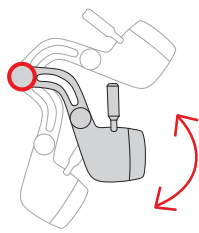

Restlaufzeit Batterie
Remaining battery power



Variable Intensität
Variable intensity



Montage der Vergrößerungslinsen
Mounting the magnifier lenses

MedLED Onyx™

Vorteile

- Sehr homogenes Licht
- Großes Beleuchtungsfeld

Advantages

- Very homogeneous light
- Large illumination field

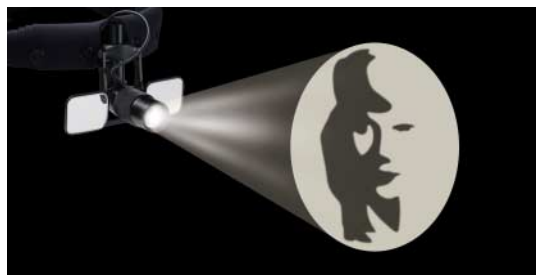
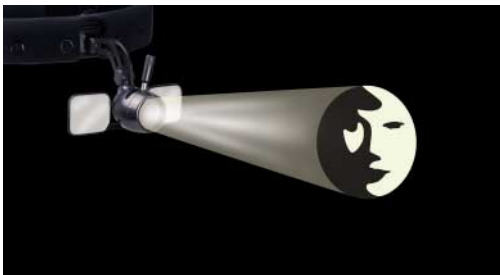
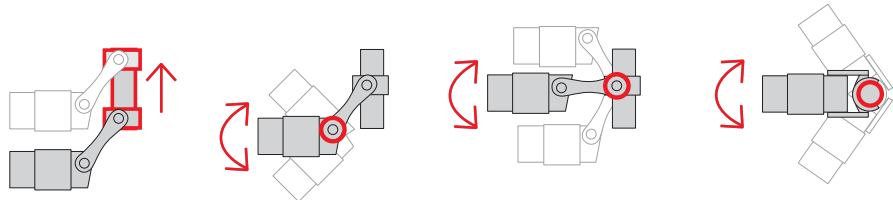
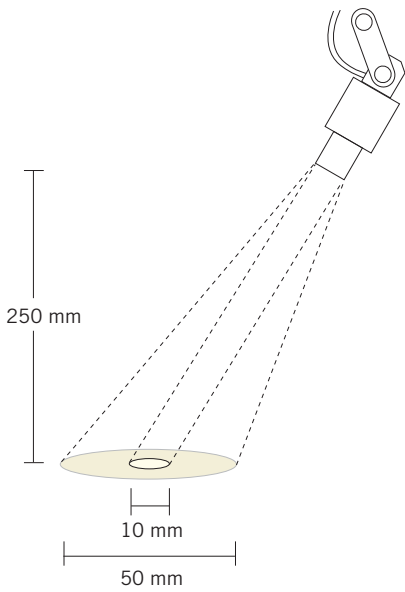

MedLED Sapphire™ – Lichtcharakteristik/Light characteristic MedLED Onyx™ – Lichtcharakteristik/Light characteristic

Für jeden Anwender die richtige Sicht

Egal, ob ein starkes Licht mit einer perfekten Tiefenausleuchtung oder ein breites und sehr homogenes Lichtfeld verlangt wird – mit den Stirnleuchten MedLED Sapphire™ und MedLED Onyx™ kann nun jeder Anwender die für sich persönlich richtige Wahl treffen!

The right vision for every user

No matter whether the requirement is strong light with perfect depth illumination or a wide and very homogeneous light field – with the MedLED Sapphire™ and MedLED Onyx™ headlamps any user can now make the right personal choice!



MedLED Sapphire™

	<p>bestehend aus:</p> <p>Stirnleuchte MedLED Sapphire™, Transportkoffer mit Tragegurt, USB-Ladekabel, Netzteil inkl. Adapter EU, US, UK, AU und 2 Akkus (Lithium-Ionen)</p>	<p>Item No.</p> <p>17-500-10-04</p>
	<p>consisting of:</p> <p>headlight MedLED Sapphire™, carrying case with shoulder strap, USB charging cable, PSU incl. adapter for EU, US, UK, AU and 2 rechargeable lithium-ion batteries</p>	

MedLED Onyx™

	<p>bestehend aus:</p> <p>Stirnleuchte MedLED Onyx™, Transportkoffer mit Tragegurt, USB-Ladekabel, Netzteil inkl. Adapter EU, US, UK, AU und 2 Akkus (Lithium-Ionen)</p>	<p>Item No.</p> <p>17-500-20-04</p>
	<p>consisting of:</p> <p>headlight MedLED Onyx™, carrying case with shoulder strap, USB charging cable, PSU incl. adapter for EU, US, UK, AU and 2 rechargeable lithium-ion batteries</p>	



Vergrößerungslinsen
Magnifier lenses

Vergrößerung Magnification	Dioptrin Diopter	Vergrößerung Magnification	Erhöhung der Sehstärke Increase in eyesight	Optische Leistung Optical power	Empfohlener Arbeits- abstand (Brennweite) Recommended working distance (focal length)	Art.-Nr. Item No.
	+ 2	+ 0.40	40 %	1.4 x	250 mm	17-500-12-04
	+ 3	+ 0.60	60 %	1.6 x	220 mm	17-500-13-04
	+ 4	+ 0.80	80 %	1.8 x	200 mm	17-500-14-04

Ladegerät/Netzstecker (optional)
Desktop charger/Mains plug (optional)

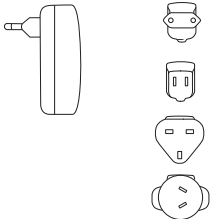
		Item No.	
	EU		17-500-01-04
	US		17-500-02-04
	UK		17-500-03-04
	AU		17-500-04-04

Ersatzakkus (2 St.)
Spare batteries, rechargeable (2 pcs.)

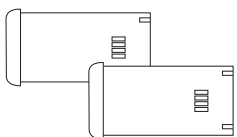

17-500-15-04

Ladegerät
Desktop charger

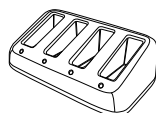

17-500-17-04

Koffer
Carrying case

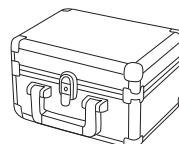

17-500-16-04

Ersatzstirnbänder
Spare head bands

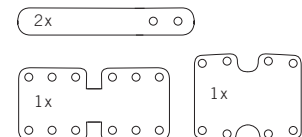

17-500-18-04